

04083

INTERFACCIA COMANDI AL VOLANTE STEERING-WHEEL CONTROLS INTERFACE INTERFACE POUR COMMANDE AU VOLANT INTERFACE FÜR LENKRAD-STEUERUNGEN INTERFAZ PARA MANDOS DE VOLANTE

- Schemi di collegamento e programmazione **IT**
- Connection diagrams and programming **EN**
- Schémas de connexion et programmation **FR**
- Anschlusspläne und programmierung **DE**
- Diagramas de conexión y programación **ES**

Leggere attentamente le istruzioni al fine di familiarizzare con tutti i controlli.
Carefully read the instructions in order to get familiar with the various control keys.
Lire les Instructions avec attention, afin de familiariser avec les touches de commande.
Anweisungen aufmerksam durchlesen und sich gut mit den Kontroll-Knöpfen auseinander setzen.
Leer atentamente las instrucciones con el fin de familiarizarse con todos los controles.

Indice • Index • Index • Index • Índice

IMPORTANTI ISTRUZIONI DI SICUREZZA E AVVERTENZE	3
IMPORTANT SAFETY INSTRUCTIONS AND WARNINGS	3
IMPORTANTES CONSIGNES DE SÉCURITÉ ET MISES EN GARDE	3
WICHTIGE SICHERHEITSANWEISUNGEN UND WARNHINWEISE	3
INSTRUCCIONES Y ADVERTENCIAS IMPORTANTES DE SEGURIDAD	3
Collegamenti adattatori autoradio	4, 5
Car-radio adapters connections	4, 5
Branchements adaptateurs autoradio	6, 7
Autoradio-Adapter anschlüsse	6, 7
Conexiones adaptadores autorradio	8
Collegamenti • Connection • Connexion • Anschluss • Conexion	10
Programmazione comandi al volante e autoradio	
Memorizzazione tasti	
Memorizzazione profilo autoradio	22
Programming of steering-wheel commands and car-radio	
Memorizing the keys	
Memorizing the car-radio profile	24
Programmation commandes au volant et autoradio	
Mémorisation touches	
Mémorisation profil autoradio	26
Programmierung von lenkrad-steuerungen und autoradio	
Tasten-speicherung	
Autoradio-profil-speicherung	28
Programacion mandos de volante y autoradio	
Memorización teclas	
Memorización perfil autoradio	30



IT - IMPORTANTI ISTRUZIONI DI SICUREZZA E AVVERTENZE

La Phonocar Spa declina ogni responsabilità in merito all'utilizzo non conforme alle leggi vigenti del INTERFACCIA COMANDI AL VOLANTE cod. 04083. Leggere attentamente le istruzioni di montaggio per seguire le indicazioni d'installazione e familiarizzare con tutti i controlli, qui di seguito alcune indicazioni: 1) I collegamenti e l'installazione devono essere effettuati da personale formato e informato. 2) Sistemare i cavi in modo che non vengano piegati o compressi da parti metalliche taglienti. 3) Non installare in luoghi umidi o polverosi. 4) Non smontare o modificare l'apparecchio. 5) Utilizzare il prodotto in veicoli con batteria da 12V. 6) Usare fusibili di ricambio dell'ampereggio corretto. 7) Eseguire correttamente i collegamenti. 8) Evitare che i cavi si impiglino agli oggetti circostanti. La Phonocar Spa declina ogni responsabilità in merito alle eventuali modifiche al colore dei cavi e la definizione dei PIN effettuate dal costruttore del veicolo.



EN - IMPORTANT SAFETY INSTRUCTIONS AND WARNINGS

Phonocar Spa declines all responsibility for any use of the STEERING-WHEEL CONTROLS INTERFACE code 04083 not in compliance with the current laws. Carefully read the mounting instructions to follow the installation directions and to become familiar with all the controls, some of which are described below: 1) Installation and Connections need to be carried out by trained and well-informed personnel. 2) Place the cables in such a way to avoid that they get folded or compressed by sharp metal pieces. 3) Do not install in humid or dusty locations. 4) Do NOT open or modify the appliance. 5) Use the product only on vehicles having a 12V-battery. 6) Make sure replacement fuses have the correct Amp-value. 7) Make sure the connections are carried out correctly. 8) Avoid that the cables get imprisoned by nearby objects. Phonocar Spa declines all responsibility for any changes to the cables colour and PIN definition made by the vehicle manufacturer.



FR - IMPORTANTES CONSIGNES DE SÉCURITÉ ET MISES EN GARDE

Phonocar Spa n'est en aucun cas responsable de l'utilisation non conforme aux législations en vigueur de l'INTERFACE POUR COMMANDE AU VOLANT Réf. 04083. Lire attentivement la notice de montage et suivre les indications d'installations pour mieux familiariser avec tous les contrôles ci-dessous quelques indications: 1) L'installation et les Connexions doivent être effectuées par du personnel spécialisé et bien informé sur le produit. 2) Positionner les câbles de manière à éviter qu'ils soient pliés ou comprimés par les parties métalliques. 3) Ne pas installer dans des endroits humides ou poussiéreux. 4) Ne pas ouvrir ou modifier l'appareil. 5) Utiliser le produit exclusivement sur des véhicules avec une batterie à 12V. 6) Utiliser les fusibles de rechange dont l'ampérage est correct. 7) Effectuer les connexions de manière correcte. 8) Éviter que les câbles puissent s'accrocher aux objet voisins. Phonocar Spa n'est pas responsable des éventuels changements des couleurs des câbles et de la définition des PIN effectués par les industries automobiles.



DE - WICHTIGE SICHERHEITSANWEISUNGEN UND WARNHINWEISE

Phonocar Spa lehnt jede Verantwortung für die Verwendung ab, die nicht den Gesetzen des INTERFACE FÜR LENKRAD-STEUERUNGEN code 04083 entspricht. Lesen Sie die Montageanweisungen sorgfältig durch, um die Installationsanweisungen zu befolgen, und machen Sie sich mit allen Bedienelementen vertraut. Nachfolgend einige Hinweise: 1) Anschlüsse und Installation müssen von geschultem Fachpersonal durchgeführt werden. 2) Ordnen Sie die Kabel so an, dass diese nicht verbogen oder zusammengedrückt werden. Von scharfen Metallteilen fernhalten um eine Abtrennung zu vermeiden. 3) Nicht an feuchten oder staubigen Montagestellen installieren 4) Das Gerät niemals auseinander nehmen oder Änderungen vornehmen. 5) Das Produkt nur auf Fahrzeugen verwenden, die über eine 12V-Batterie verfügen. 6) Beim Austauschen der Sicherungen immer auf den korrekten Ampere-Wert achten. 7) Elektro-Verbindungen korrekt vornehmen und kontrollieren. 8) Sicherstellen, dass sich die Kabel nicht an naheliegenden Gegenständen verhängen können. Phonocar Spa lehnt jede Verantwortung für eventuelle Änderungen der Farbe der Kabel bzw. der PIN-Bestimmung durch den Fahrzeughersteller ab.



ES - INSTRUCCIONES Y ADVERTENCIAS IMPORTANTES DE SEGURIDAD

Phonocar Spa declina cualquier responsabilidad por el uso del dispositivo que no cumpla con las leyes vigentes del INTERFAZ PARA MANDOS DE VOLANTE código 04083. Lea atentamente las instrucciones de montaje y familiarícese con todos los controles, a continuación encontrará algunas indicaciones: 1) Las conexiones y la instalación deben ser realizadas por personal capacitado e informado. 2) Organice los cables para que no estén doblados o comprimidos entre piezas metálicas afiladas. 3) No instalar el dispositivo en lugares húmedos o polvorientos. 4) No desarme ni modifique el aparato. 5) Use el producto en vehículos con batería de 12V. 6) Use fusibles de repuesto con ampere correcto. 7) Realice las conexiones correctamente. 8) No permita que los cables queden atrapados en objetos circundante. Phonocar Spa declina cualquier responsabilidad por cualquier cambio en el color de los cables y la definición de los PIN realizados por el fabricante del vehículo.

ALPINE

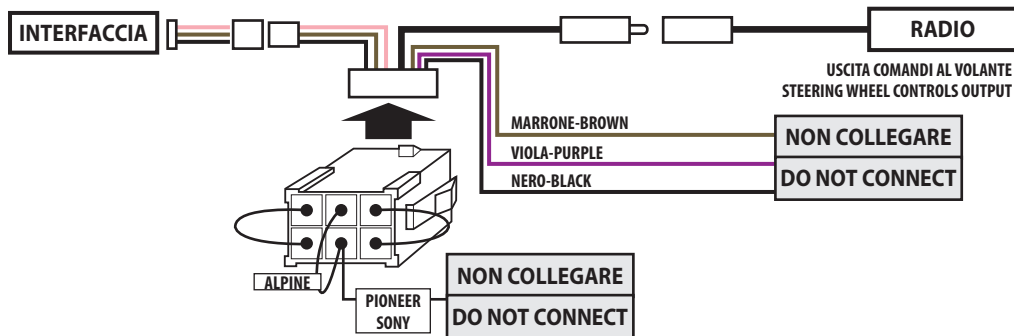

BLAUPUNKT MODELLI SENZA COMANDI AL VOLANTE INTEGRATI RESISTIVI
MODELS WITHOUT RESISTIVE INTEGRATED STEERING WHEEL CONTROLS

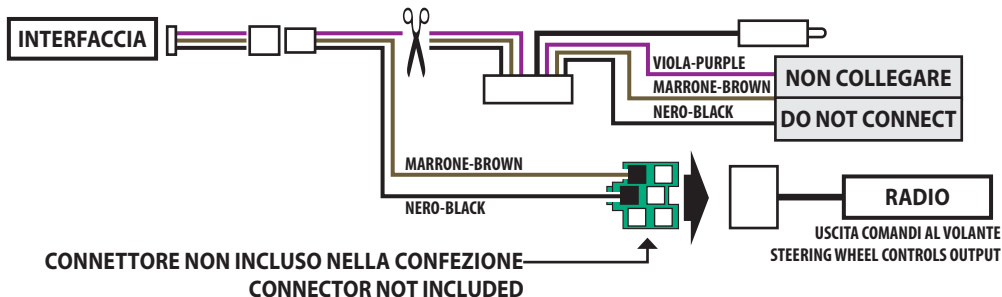

CLARION, JVC >2011, PHONOCAR VM044, VM057 (JACK 3.5")

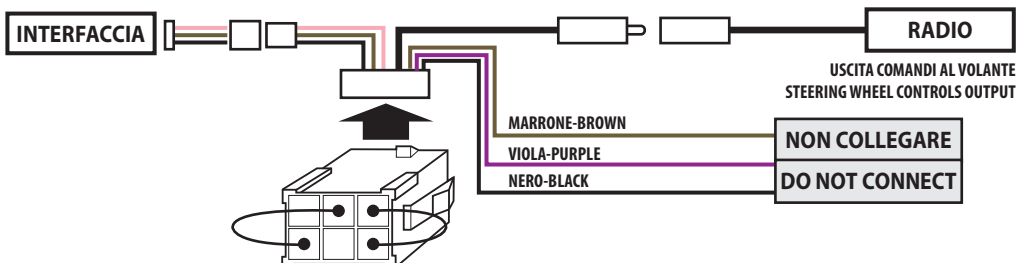

**BLAUPUNKT NEW YORK serie 800, SAN DIEGO serie 530
PHONOCAR VM028, VM051 - PIONEER - SONY**

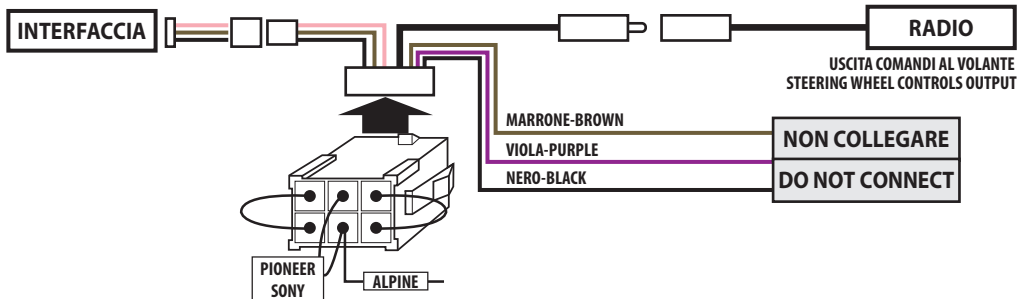

ATTENZIONE: Con i prodotti Phonocar VM051, Blaupunkt New York 800 e San Diego 530 dopo aver programmato l'interfaccia ED EFFETTUATO I COLLEGAMENTI, memorizzare i comandi al volante SULL'AUTORADIO seguendo le indicazioni presenti nel suo libretto di istruzioni capitolo "PROGRAMMAZIONE COMANDI AL VOLANTE".

IMPORTANT: For Phonocar-model VM051, BLK NewYork 800 and SanDiego 530: After having programmed the central-box, please MEMORIZE the steering-wheel commands by following the related instructions you find in the radio-Manual, chapter "PROGRAMMING THE STEERING-WHEEL CONTROLS".

**BLAUPUNKT ISO NORM - PHONOCAR VM001, VM001D, VM002, VM009, VM010, VM011D,
VM012, VM030 2017>, VM057, VM066, VM067, VM069**

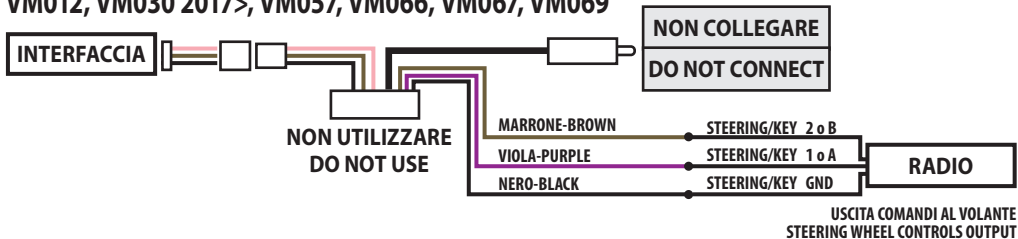

ATTENZIONE: Dopo aver programmato l'interfaccia ED EFFETTUATO I COLLEGAMENTI, memorizzare i comandi al volante SULL'AUTORADIO seguendo le indicazioni presenti nel suo libretto di istruzioni capitolo "PROGRAMMAZIONE COMANDI AL VOLANTE".

IMPORTANT: After having programmed the central-box, please MEMORIZE the steering-wheel commands by following the related INSTRUCTIONS you find in the radio-Manual, chapter "PROGRAMMING THE STEERING-WHEEL CONTROLS".

CLARION - JVC 2011> - KENWOOD - PHONOCAR VM017, VM021, VM062, VM063

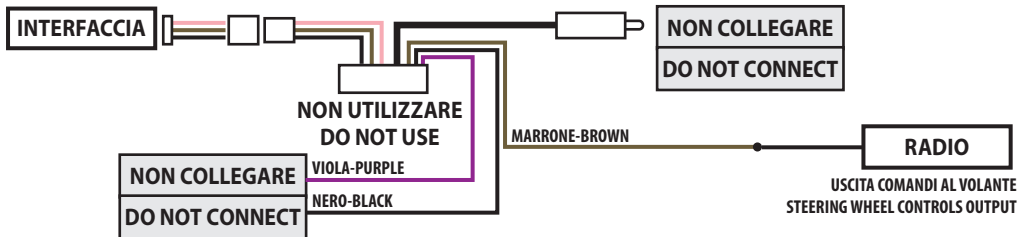

ALPINE

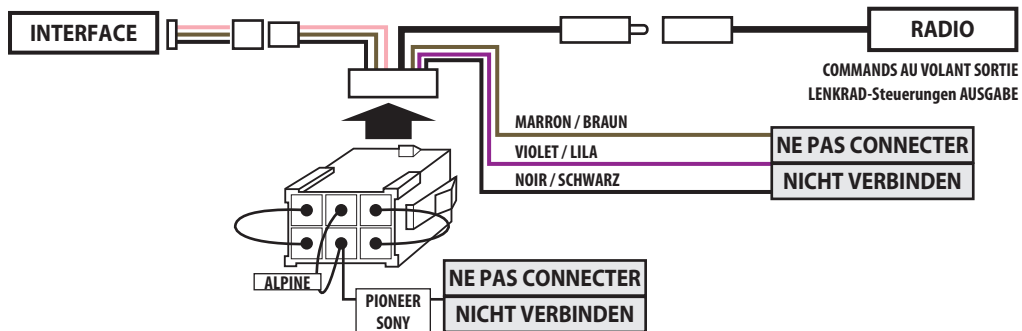

**MODÈLES SANS COMMANDS AU VOLANT RESISTIVE INTÉGRÉES
 MODELLE OHNE LENKRAD-Steuerungen RESISTIVE INTEGRIERTE**

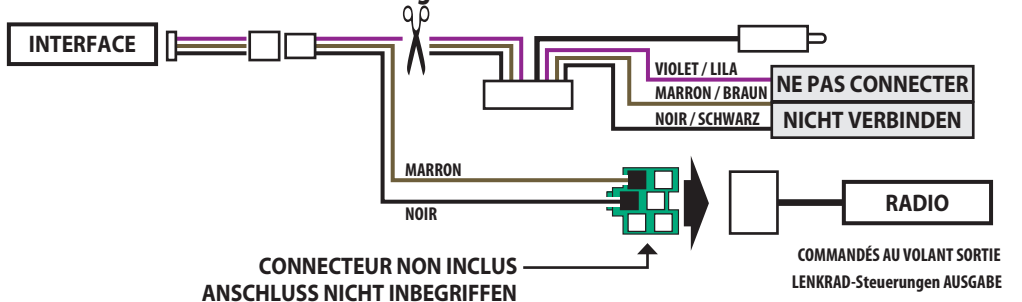

CLARION, JVC >2011, PHONOCAR VM044, VM057 (jack 3.5")

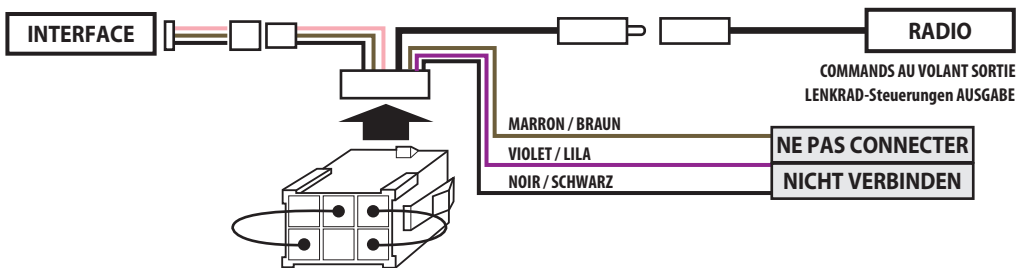

**BLAUPUNKT NEW YORK 800 SERIES, SAN DIEGO 530 SERIES
 PHONOCAR VM028, VM051 - PIONEER - SONY**

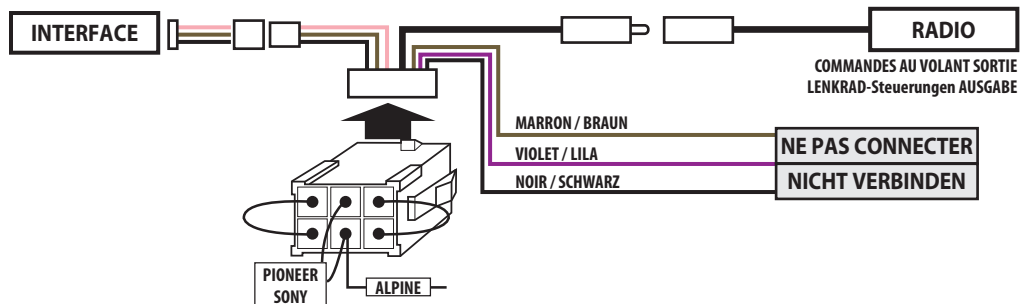

ATTENTION: Avec les produits Phonocar VM051, Blaupunkt New York 800 et de San Diego 530 après la programmation du dispositif, réglez les Commandes au Volant en suivant les instructions du manuel de la radio "PROGRAMMATION COMMANDES AU VOLANT".

WICHTIG: Für PHONOCAR-Modell VM051, Blaupunkt NewYork800 und SanDiego530: Nachdem Sie die Zentraleinheit programmiert haben, bitte die Lenkrad-Steuerungen EINSPEICHERN, indem Sie die ANWEISUNGEN befolgen, lt. Radio-Handbuch, Abschnitt "PROGRAMMIERUNG DER LENKRAD-STEUERUNGEN".

**BLAUPUNKT ISO NORM - PHONOCAR VM001, VM001D, VM002, VM009, VM010, VM011D,
 VM012, VM030 2017>, VM057, VM066, VM067, VM069**

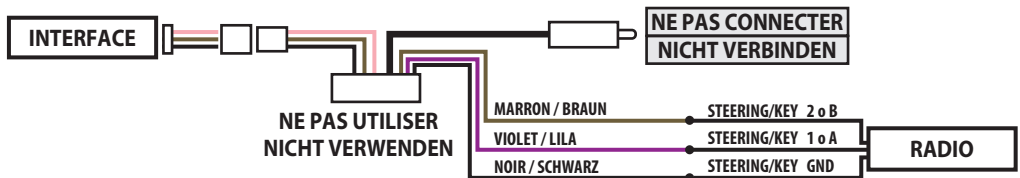

ATTENTION: Après la programmation du dispositif, réglez les Commandes au Volant en suivant les instructions du manuel de la radio "PROGRAMMATION COMMANDES AU VOLANT".

WICHTIG: Nachdem Sie die Zentraleinheit programmiert haben, bitte die Lenkrad-Steuerungen EINSPEICHERN, indem Sie die ANWEISUNGEN befolgen, lt. Radio-Handbuch, Abschnitt "PROGRAMMIERUNG DER LENKRAD-STEUERUNGEN".

CLARION - JVC 2011> - KENWOOD - PHONOCAR VM017, VM021, VM062, VM063

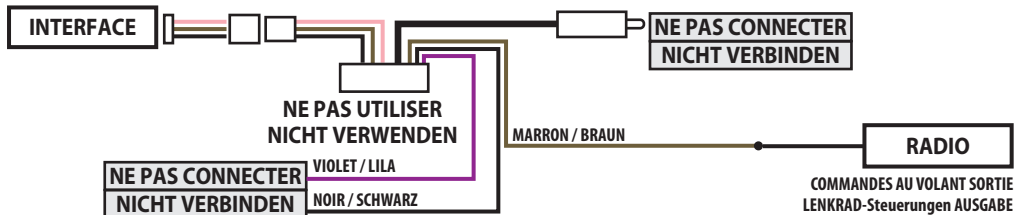

ALPINE

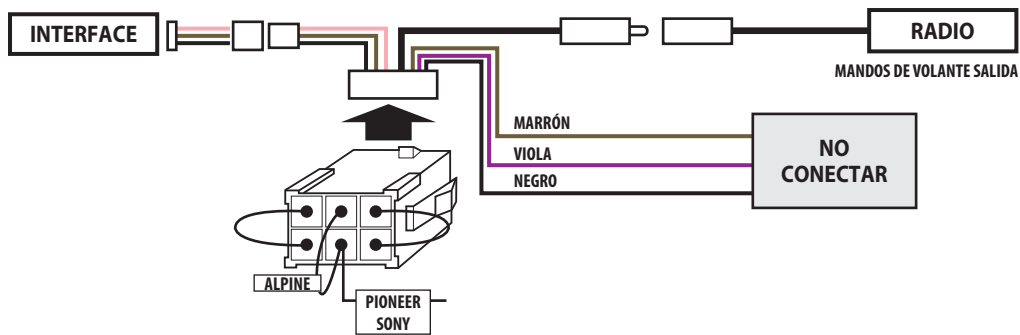

MODELLE OHNE LENKRAD-Steuerungen RESISTIVE INTEGRIERTE

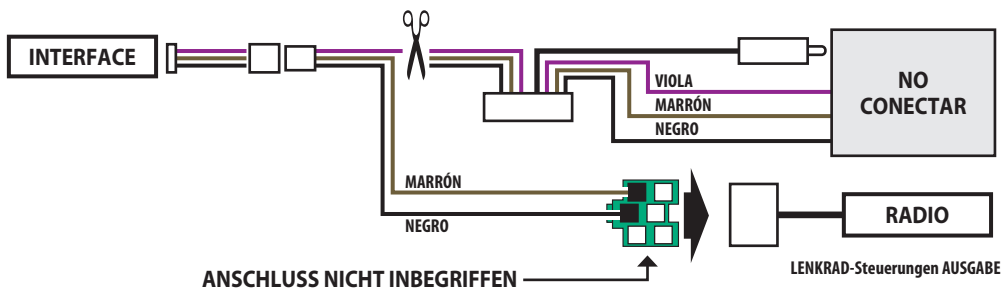

CLARION, JVC >2011, PHONOCAR VM044, VM057 (jack 3.5")

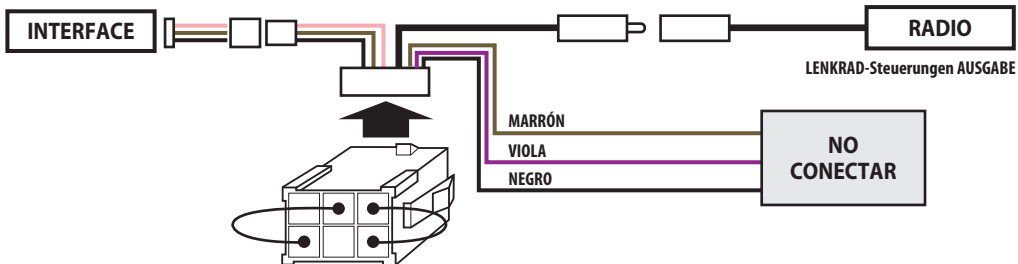

**BLAUPUNKT NEW YORK SERIE 800, SAN DIEGO SERIE 530
PHONOCAR VM028, VM051 - PIONEER - SONY**

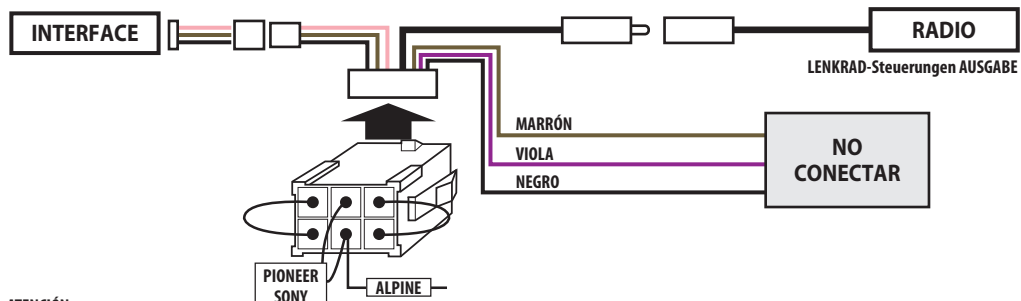

ATENCIÓN:

Con los productos Phonocar VM051, Blaupunkt New York 800 e San Diego 530 después de programar la unidad, ajustar los Mandos de Volante siguiendo el manual de instrucciones del radio de coche "MANDOS DE VOLANTE".

**BLAUPUNKT MODELOS ISO NORM
PHONOCAR VM001, VM001D, VM002, VM009, VM010, VM011D, VM012, VM030 2017>,
VM057, VM066, VM067, VM069**

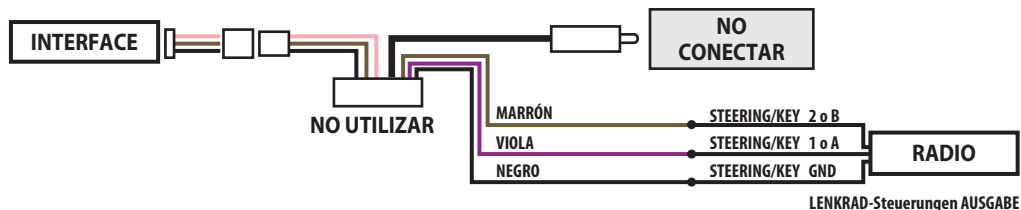

ATENCIÓN:

Después de programar la unidad, ajustar los mandos en el volante siguiendo el manual de instrucciones del radio de coche "VOLANTE DE PROGRAMACIÓN".

CLARION - JVC 2011> - KENWOOD - PHONOCAR VM017, VM021, VM062, VM063

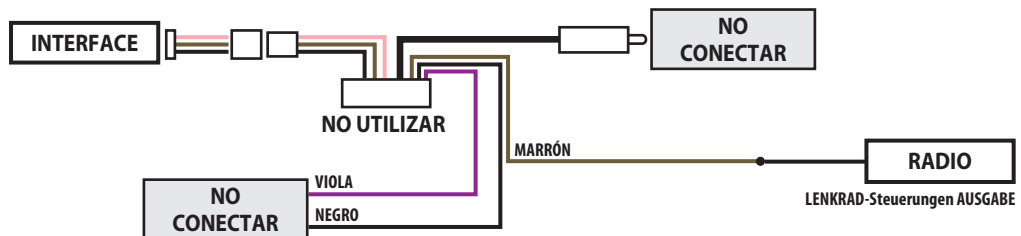

! IT - ATTENZIONE I disegni dei connettori riproducono il lato uscita cavi. Il colore dei cavi originali per i comandi al volante può variare, in questo caso collegarsi rispettando la posizione dei cavi sul connettore.

! EN - ATTENTION The clamp-holders are shown from the cables-exit. The colour of the original steering-wheel commands-cables may be different. If so, please connect cables in due respect of the cable-positions foreseen on the clamp-holder.

! FR - ATTENTION Les dessins des connecteurs montrent la sortie des câbles la couleur des câbles originaux des commandes au volant peut changer dans ce cas, se connecter en respectant la position des câbles sur le connecteur.

! DE - HINWEIS Die Klemmenhalter sind vom Kabel-Ausgang aus betrachtet. Die Original-Kabelfarbe der Lenkradsteuerungen könnte anders sein. In solch einem Falle, die Kabel nach Vorgabe des Klemmenhalters anlegen.

! ES - ATENCIÓN Los dibujos de los conectores reproducen el lado de salida de los cables. El color de los cables originales para los mandos de volante pueden variar, en este caso conectarse respetando la posición de los cables en el conector.

IT -NOTE

- 1 In alcuni modelli di auto il comando seek(-) non si attiva.
- 2 Connettore nel vano autoradio.
- 3 Connettore sotto la leva dei comandi al volante.
- 4 Connettore del display dell'autoradio.
- 5 Connettore presente sotto lo sterzo.
- 6 Il connettore si trova dietro il body computer

FR -NOTES

- 1 Dans certains modèles de véhicule la commande seek (-) ne s'active pas.
- 2 Connecteur dans l'emplacement autoradio.
- 3 Connecteur sous le levier des commandes au volant.
- 4 Connecteur du display de l'autoradio.
- 5 Connecteur qu'on trouve en dessous du volant.
- 6 Le connecteur se trouve derrière le body computer

DE -NOTES

- 1 In einigen Wagenmodellen lässt sich die Funktion seek (-) nicht aktivieren.
- 2 Verbinder im Radio-schacht.
- 3 Verbinder unter dem Lenkrad-steuerungs-hebel.
- 4 Verbinder des Autoradio-displays.
- 5 Verbinder befindet sich am Lenkrad-ansatz.
- 6 Der Stecker befindet sich hinter dem Body-Computer.

EN -NOTES

- 1 In some car-models, the seek(-)-control cannot be activated.
- 2 Connector inside the radio-opening.
- 3 Connector under the lever for the SWC.
- 4 Connector of the car-radio-display.
- 5 Connector located near the steering-wheel post.
- 6 The connector is behind the body computer.

ES -NOTAS

- 1 En algunos modelos de coche la función seek- no se activa.
- 2 Conector en el hueco del autoradio.
- 3 Conector por debajo de la palanca de los mandos de volante.
- 4 Conector del display del autoradio.
- 5 Conector presente debajo del volante.
- 6 El conector se encuentra detrás del body computer .

ALFA 1

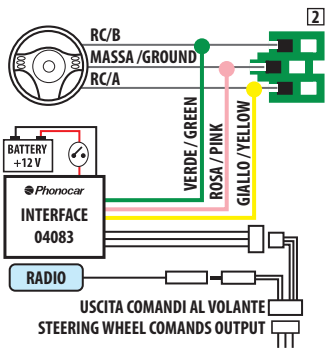

CHEVROLET Captiva 2

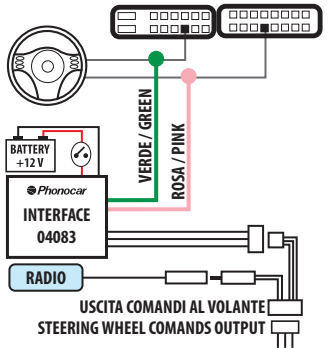

CHEVROLET 2

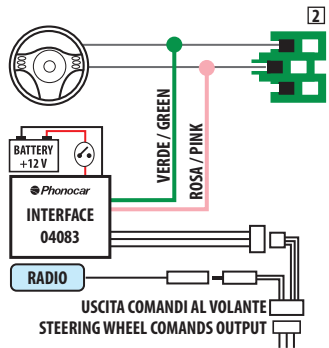

CHRYSLER JGC 2001> 3

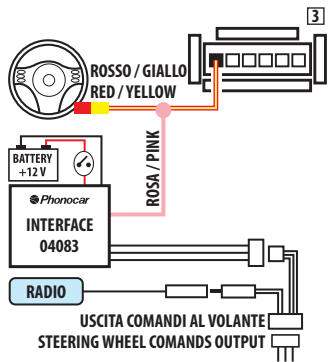

CHRYSLER Cherokee 2003>2004 - 2004>2005 3

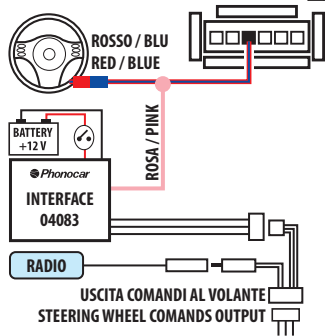

CHRYSLER Voyager 2001> 3

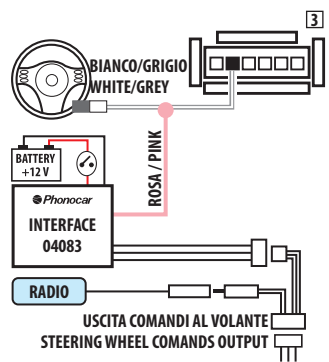

CITROËN >2002 2 3

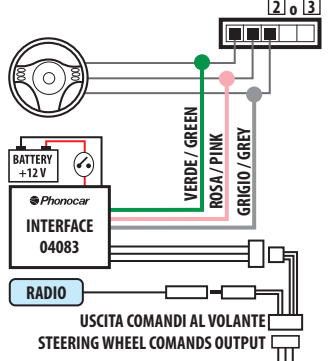

CITROËN >2002 2 3

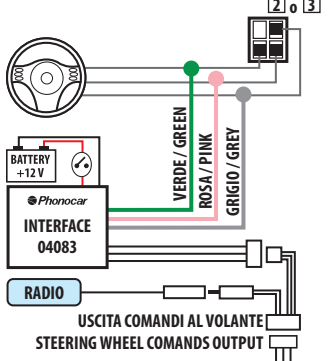

CITROËN C-Crosser 2

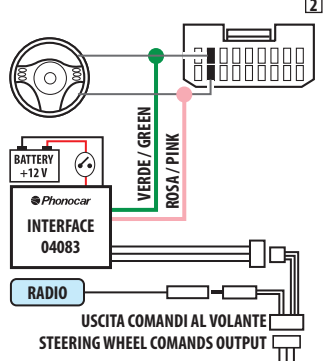

FIAT 1

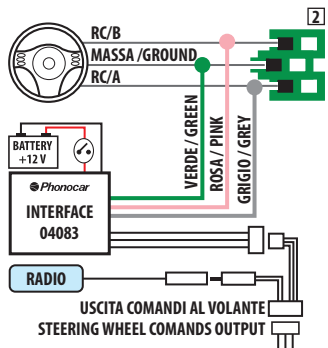

FORD C-Max, S-Max, Fiesta 2009>, Focus 2006>, Galaxi 2007>, Kuga 2007>, Mondeo 2007>

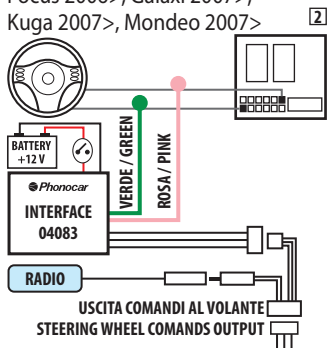

FORD C-Max >2010

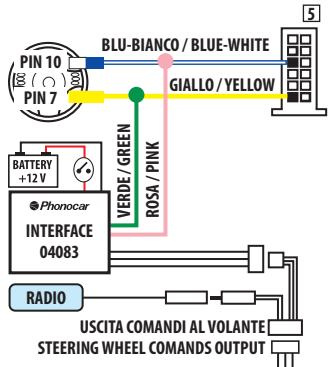

CITROËN Evasion >2004

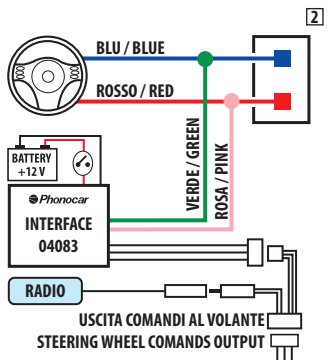

DAIHATSU Terios 2009>

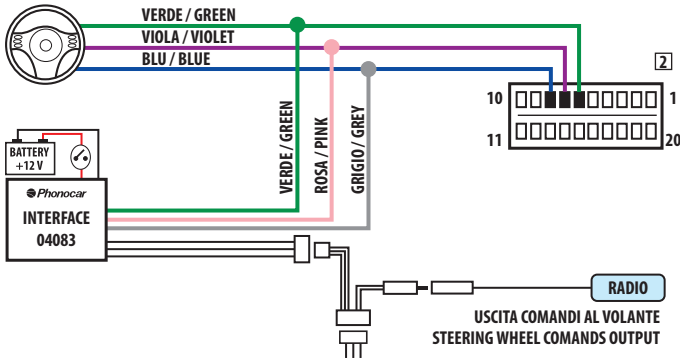

FIAT Ducato >2012

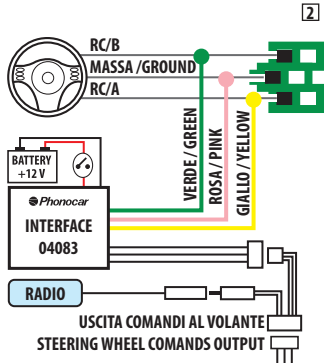

FIAT Sedici

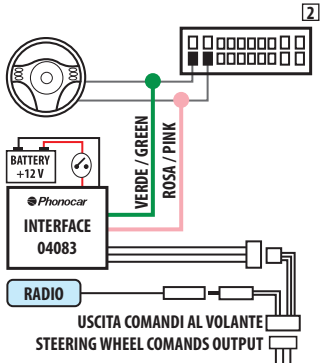

FIAT Ulisse >2004

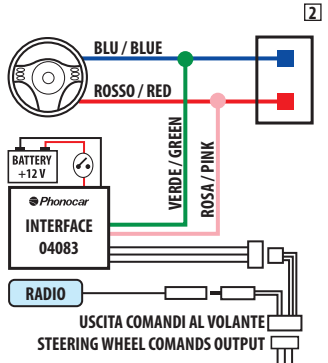

FORD Fiesta >2008

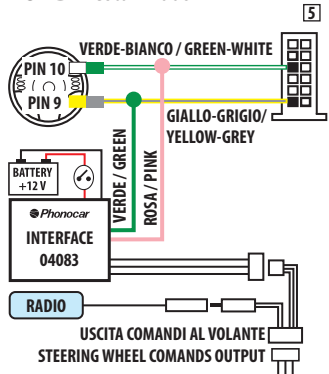

FORD Focus >2008, Fiesta 2006

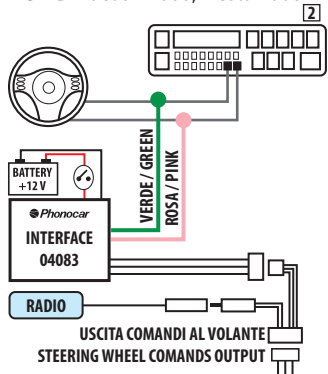

FORD Focus 2002

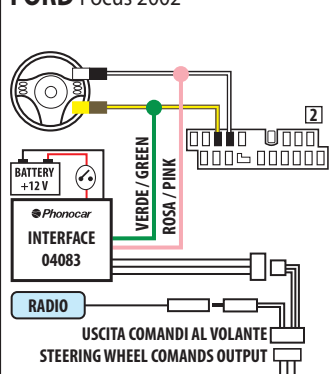

FORD Mondeo 2003>

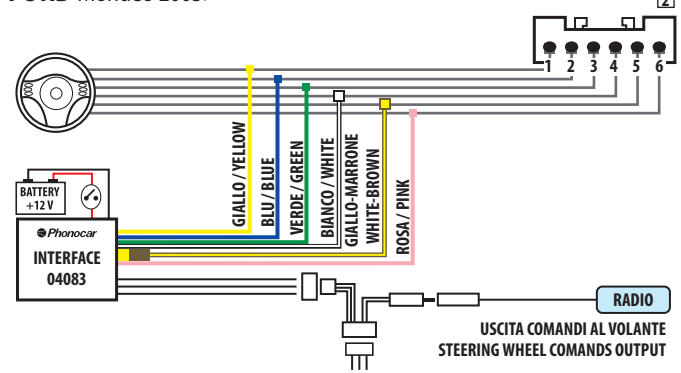

HYUNDAI Santa Fè >2009

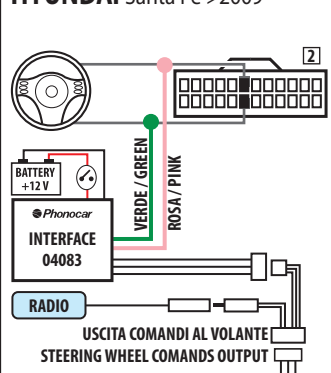

HYUNDAI

Santa Fè >2009, iX35 (ISO)

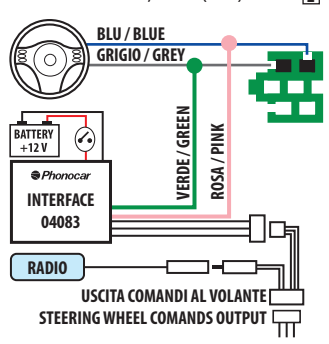

HYUNDAI iX>2011>, iX35 2011>

Tucson no navi.

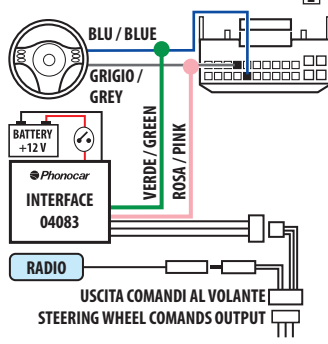

HYUNDAI Tucson navi.

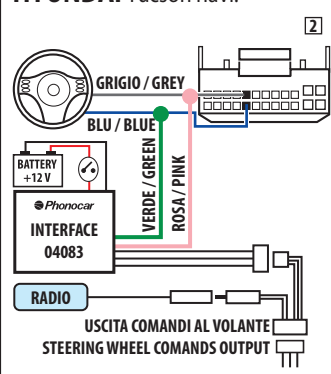

HONDA CR-V 2007>

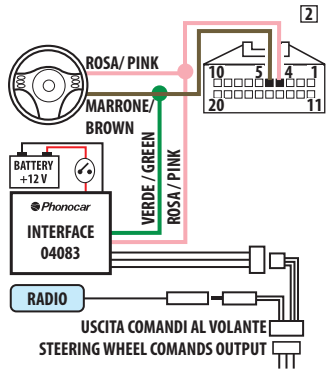

HONDA CR-V 2007>

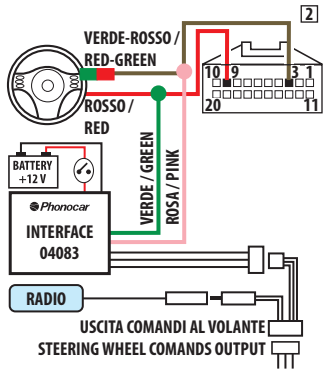

HONDA Civic 2007>, CR-V 2006>, FR-V

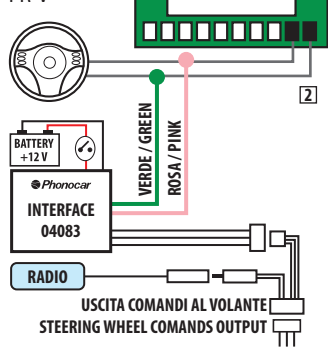

HONDA Civic 2006>

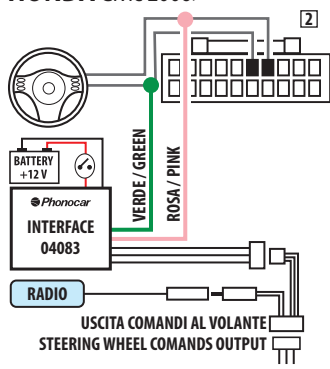

HUMMER H2

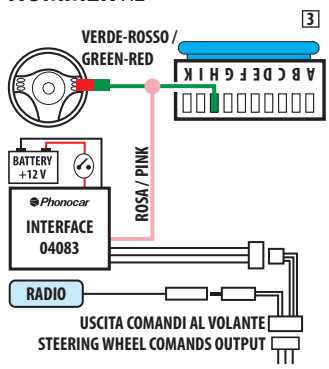

JAGUAR

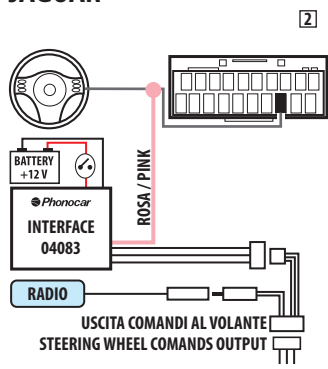

KIA Sportage 2010>, Sorento 2011>, Rio 2011>, Picanto 2011>, Venga 2011>

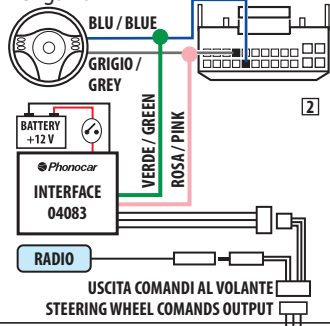

KIA Sorento 2010

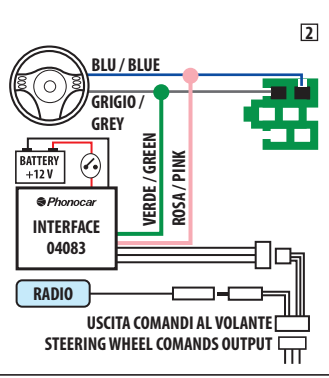

KIA Sorento >2010

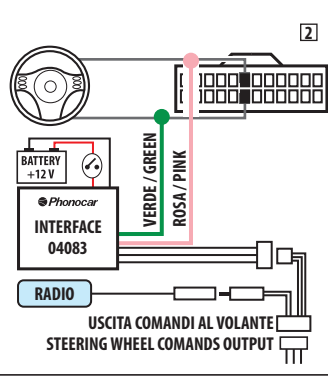

KIA C'eed

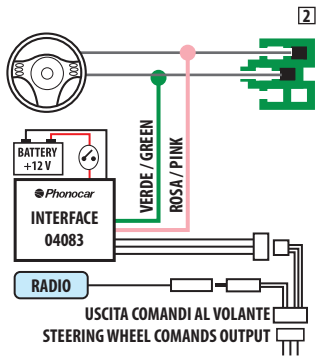

KIA

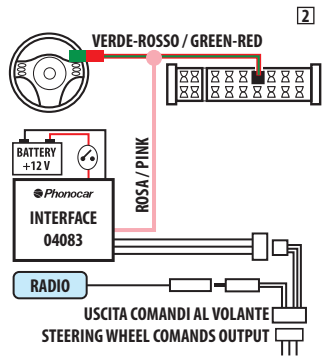

LAND ROVER

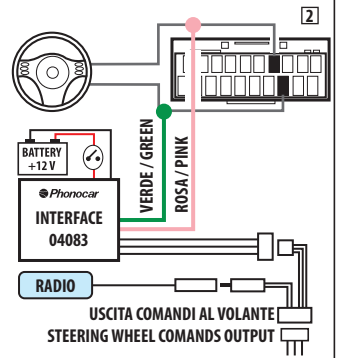

LANCIA Zeta >2004

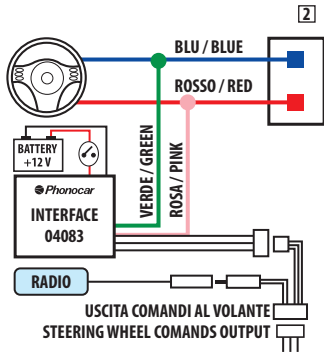

MITSUBISHI Outlander 2007>, ASX 2010>

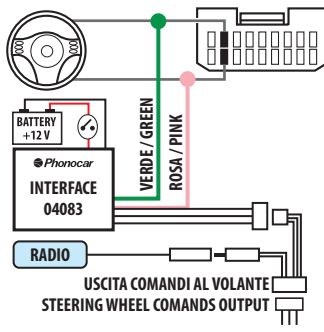

MITSUBISHI L200 2010>



MITSUBISHI Pajero

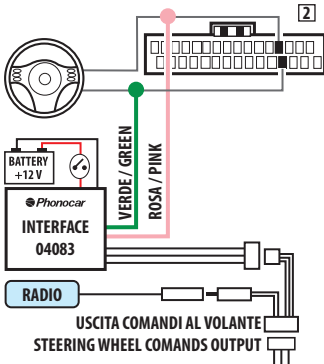

MAZDA

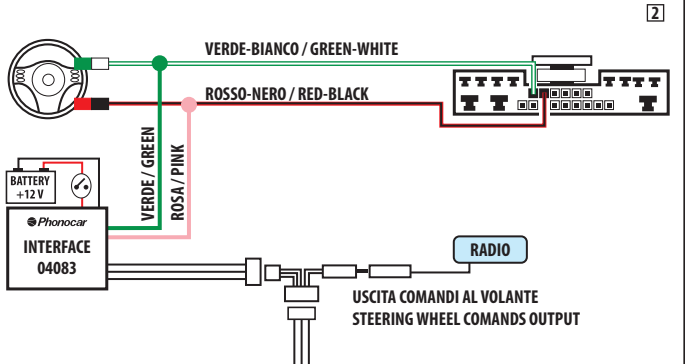

NISSAN Almera

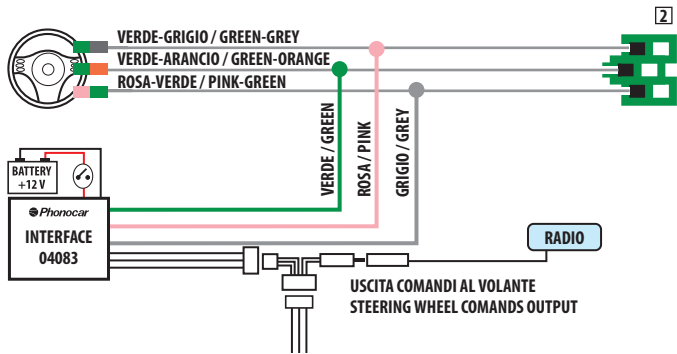

NISSAN Pathfinder

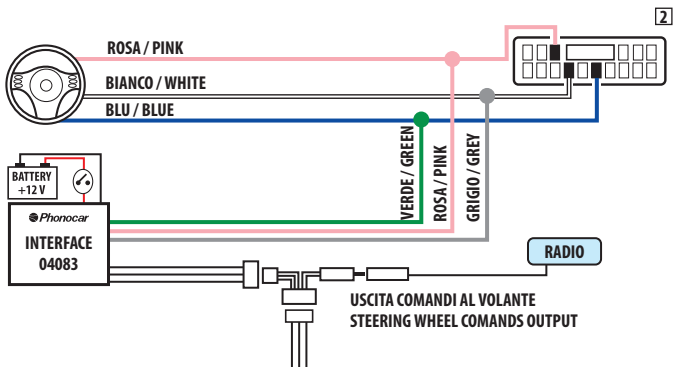

NISSAN Micra, Note

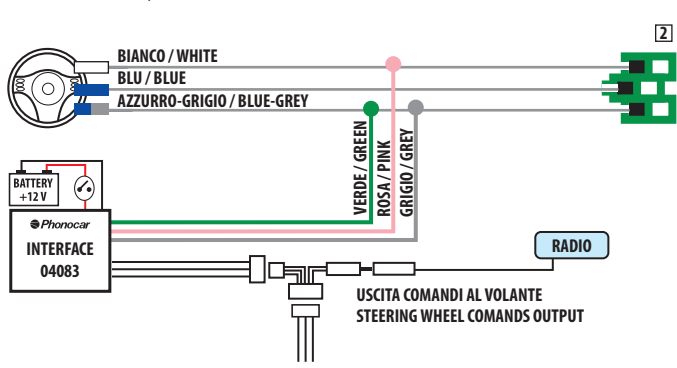

NISSAN Navarra

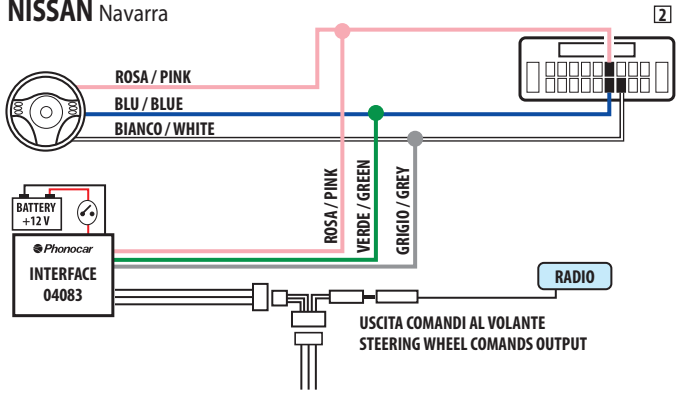

NISSAN XTrail 2008>, 350Z, Murano

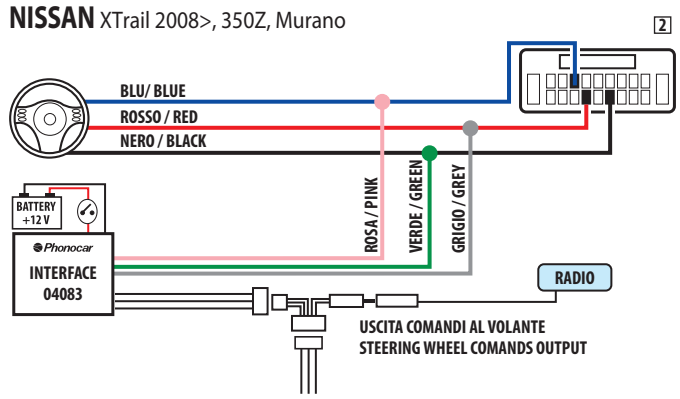

NISSAN Qasqhai >2014, Xtrail 2008>, Juke

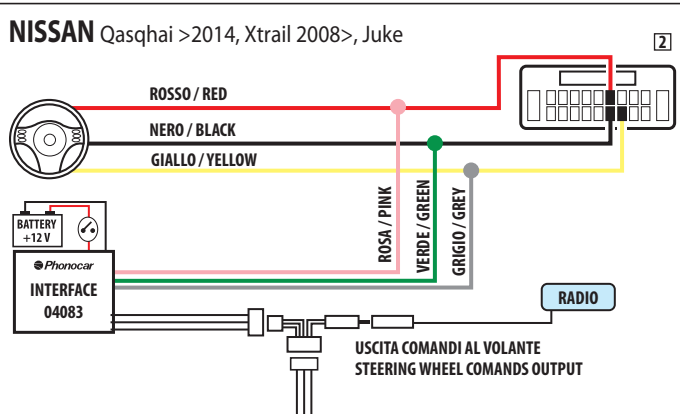

NISSAN Primastar 2008>

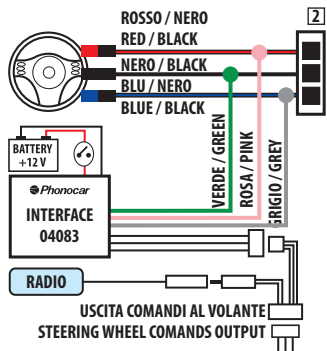

NISSAN XTrail 2006>

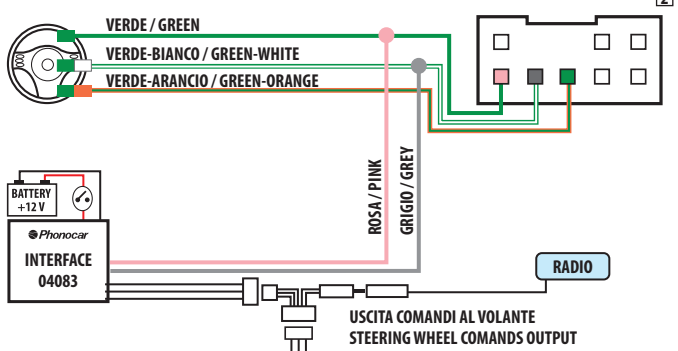

OPEL Tutti i modelli >2004

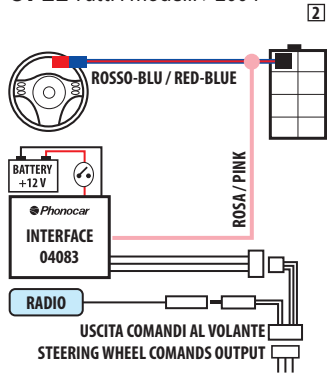

OPEL Agila 2008>

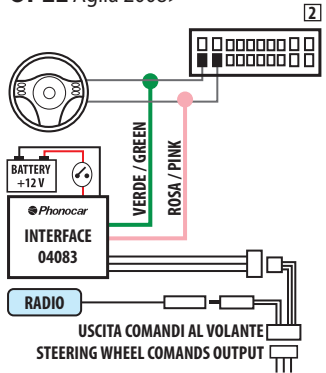

PEUGEOT >2002

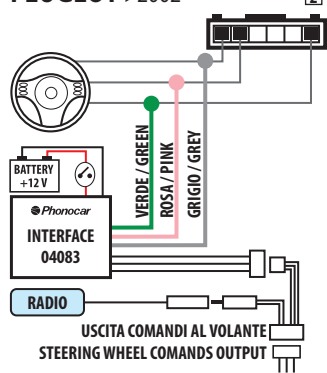

PEUGEOT 805 >2004

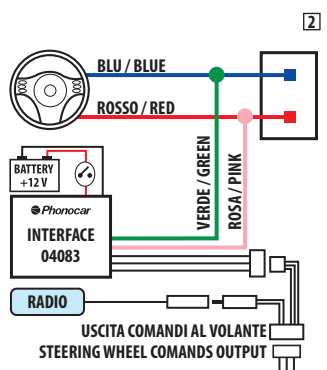

PEUGEOT 4007

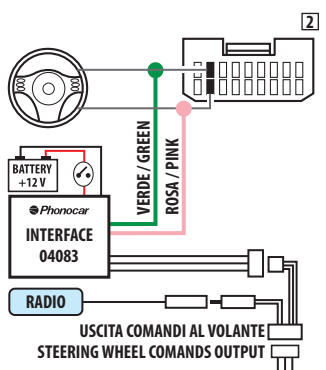

SCANIA

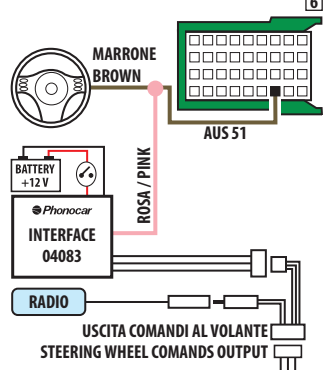

SUBARU Impreza 2008>, Forrester 2010>

2

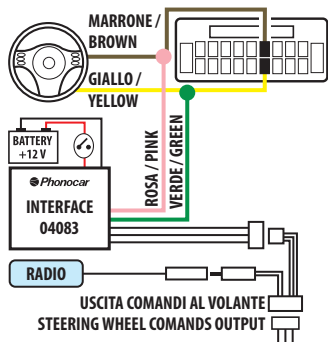

SUBARU Impreza 2009>

2

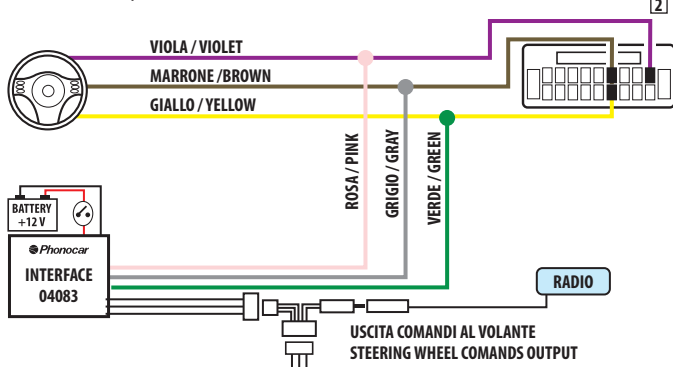

SUBARU Forrester 2008>

2

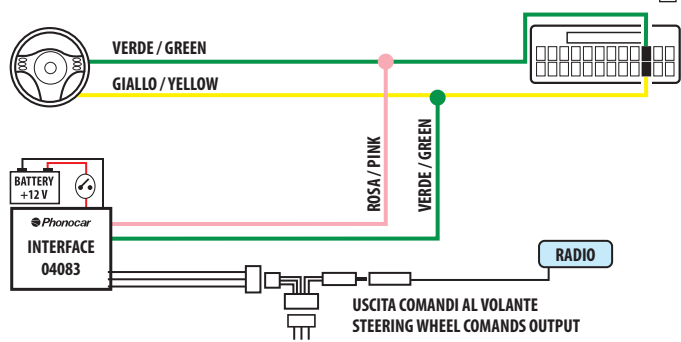

SUBARU Impreza 2010>, Outback 2010>

2

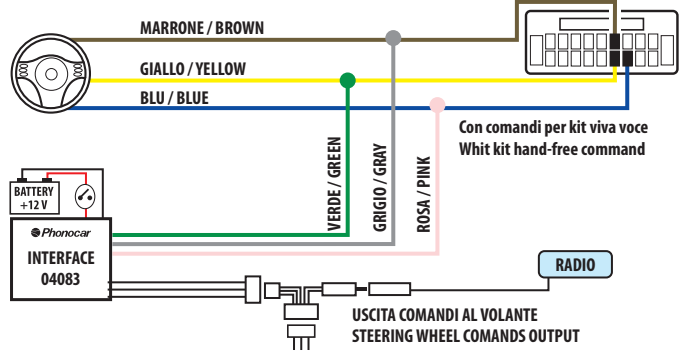

SUBARU Outback 2012>, Legacy 2012

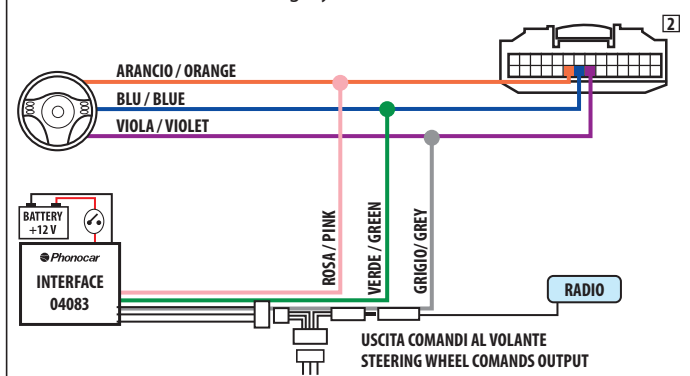

SSANGYONG Actyon, Rexton, Kyrion, Korando

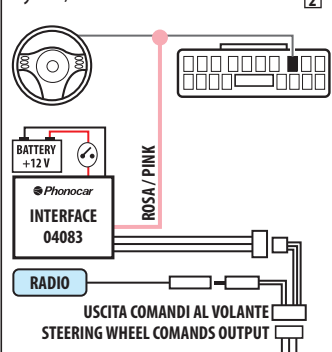

SSANGYONG Tivoli navi.

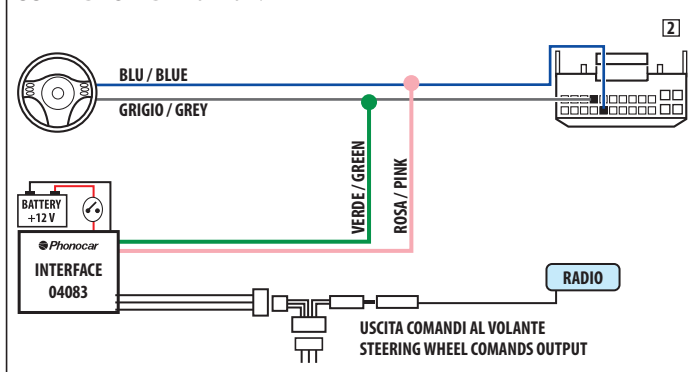

SUZUKY Alto 2008>, Gran Vitara, Sx4, Splash, Swift

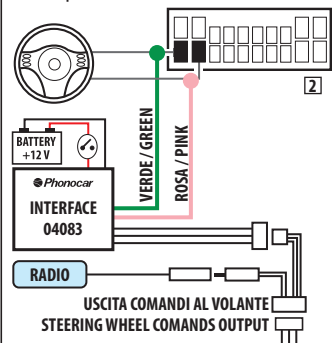

SUZUKY Celerio (Tasti BLT)

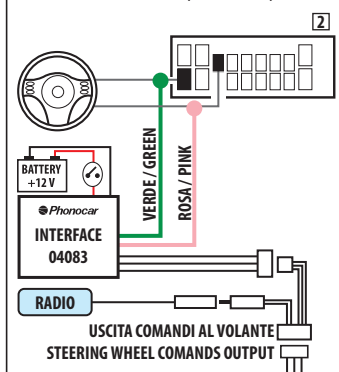

SUZUKY Gran Vitara 2004>

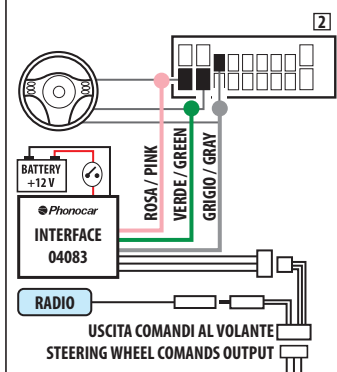

SUZUKY Gran Vitara 2004>2012

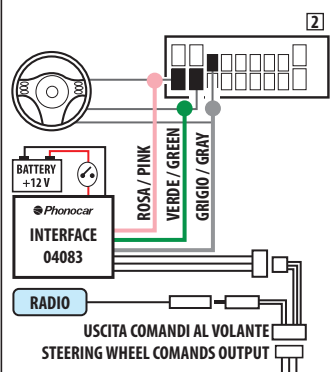

SUZUKY Gran Vitera 2012>, Swift 2011>, SX4, S-Cross, Celerio

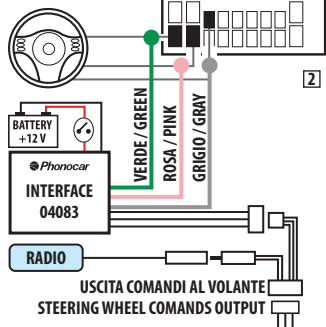

TOYOTA Corolla, Avensis, Yaris '06>, Rav 4 '06>, Auris

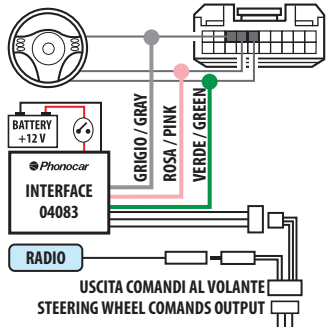

TOYOTA Yaris 2006>, Rav 4 2006>

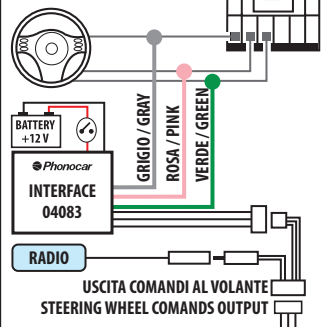

TOYOTA Hilux 2012>, Rav4 2012>, Verso 2012>, Yaris '12>

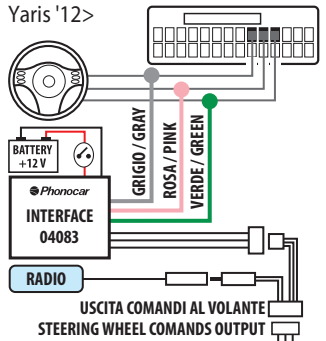

TOYOTA Verso 2012>

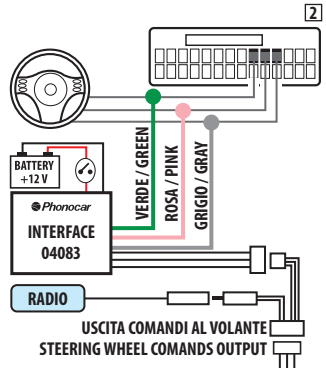

MEMORIZZAZIONE TASTI

Dopo aver effettuato i collegamenti, senza inserire il jack comandi al volante nel retro dell'autoradio ruotare la chiave di accensione ed il led si illuminerà con un lampeggio di colore rosso.













Per memorizzare correttamente le funzioni sui tasti dei comandi al volante, eseguire la programmazione iniziando dalla funzione 1 (VOL -), rispettando la sequenza presente nella tabella.

Premere il comando al volante VOL - ed il led si illuminerà con un lampeggio di colore rosso che conferma l'avvenuta memorizzazione. Lo stesso metodo dovrà essere utilizzato per memorizzare le restanti funzione 2 (VOL +), 3 (SEEK-), 4 (SEEK+) ecc.

ATTENZIONE:

L'interfaccia è predisposta per eseguire 10 funzioni (12 funzioni per modelli del 2020>) che dovranno essere TUTTE Attivate o Disattivate. L'attivazione avviene premendo i tasti presenti sul volante, mentre la disattivazione avviene premendo il tasto PRG presente sull' interfaccia.

Dopo aver configurato i tasti dei comandi al volante il led dell'interfaccia lampeggerà di colore verde.

Sequenza per memorizzare le funzioni	DESCRIZIONE DELLE FUNZIONI PRESENTI SUI TASTI AUTORADIO							
	AUTORADIO							
	Clarion	Kenwood	JVC	Pioneer	Sony	Alpine	Blaupunkt	Phonocar
1	VOLUME -							
2	VOLUME +							
3	SEEK -							
4	SEEK +							
5	FUNC	SRC 	SOURCE	MODE	SOURCE	SOURCE	SOURCE	MODE
6	MUTE	MUTE	MUTE	MUTE	MUTE	MUTE	MUTE	MUTE
7	BAND	UP	UP	UP	UP		UP	PLAY/PAUSE
8	DISP	DOWN	DOWN	DOWN	DOWN		DOWN	BAND
9	TA	SPEECH				UP	OK	 *
10	AF					DOWN	NO	 *

*Solo per VM057 (JACK3,5)

MEMORIZZAZIONE PROFILO AUTORADIO

Premere SEEK+ per memorizzare le autoradio CLARION.

Per effettuare la configurazione di altri marchi, agire sui comandi al volante premendo il tasto del Vol+ per selezionare il profilo e verificare il numero di lampeggi corretti con l'intermezzo di una pausa. In caso di errore è possibile modificare la programmazione tramite il tasto Vol+ se il numero di lampeggi è inferiore a quello della tabella e Vol- se superiore.

Premere il tasto SEEK+ per confermare. Il LED rimarrà acceso con luce verde fissa.

Collegare il cavo uscita comandi al volante presente sul retro dell'autoradio.

Verificare che i comandi funzionino correttamente. Qualora si evidenziasero delle anomalie, eseguire il reset dell'interfaccia e ripetere attentamente la procedura di programmazione.

CLARION	Non premere	Led verde 1 lampeggio	Premere seek +
KENWOOD	Premere 1 volta vol +	Led verde 2 lampeggi	Premere seek +
JVC	Premere 2 volte vol +	Led verde 3 lampeggi	Premere seek +
PIONEER	Premere 3 volte vol +	Led verde 4 lampeggi	Premere seek +
PHONOCAR VM001, VM002, VM009 2017>, VM010, VM011D, VM012, VM030 2017>, VM051, VM057, VM066 2020>, VM067, VM069 SONY	Premere 4 volte vol +	Led verde 5 lampeggi	Premere seek +
BLAUPUNKT ISO NORM	Premere 4 volte vol +	Led verde 5 lampeggi	Premere seek +
ALPINE	Premere 5 volte vol +	Led verde 6 lampeggi	Premere seek +
BLAUPUNKT	Premere 9 volte vol +	1 Lampeggio led rosso	Premere seek +
PHONOCAR VM017, VM021, VM062, VM063	Premere 11 volte vol +	1 Lampeggio led rosso + 2 verde	Premere seek +
PHONOCAR VM044	Premere 13 volte vol +	1 Lampeggio led rosso + 4 verdi	Premere seek +
BLAUPUNKT 2	Premere 20 volte vol +	2 Lampeggi led rosso + 1 verdi	Premere seek +
BLAUPUNKT NEW YORK serie 800, SAN DIEGO serie 530	Premere 23 volte vol +	2 Lampeggi led rosso + 4 verdi	Premere seek +
CLARION NX 501E	Premere 26 volte vol +	2 Lampeggi led rosso + 7 verdi	Premere seek +
CLARION NX 502E	Premere 32 volte vol +	3 Lampeggi led rosso + 3 verdi	Premere seek +
PHONOCAR VM025, VM026, VM028	Premere 34 volte vol +	3 Lampeggi led rosso + 5 verdi	Premere seek +

RESET GENERALE

Staccare il connettore dall'interfaccia e tenendo premuto il tasto PRG, reinserire il connettore.

Il LED dell'interfaccia inizierà a lampeggiare lentamente poi velocemente a questo punto togliere la pressione dal tasto PRG. L'avvenuto RESET sarà confermato con un solo lampeggio di colore rosso del LED. Nel caso non si verificasse, ripetere l'operazione.

ESEMPIO di procedura per la programmazione di un'autoradio Clarion con disponibilità sul volante di 5 tasti volendo ottenere i comandi di Vol-, Vol+, Seek-, Seek+, MUTE.

Sequenza: premere una sola volta Vol-, Vol+, Seek-, Seek+, il tasto PRG sull'interfaccia per disattivare la funzione (FUNC), il tasto destinato al comando MUTE ed infine premere 4 (6 volte per modelli dal 2020) volte il tasto PRG per completare la programmazione. L'avvenuta corretta programmazione, sarà confermata dal lampeggiare continuo del LED di colore verde.

Procedere per la memorizzazione dell'autoradio.

MEMORIZING THE KEYS

After having effected the connections, and without introducing the Jack of the steering-wheel commands on the back of the car-radio, turn the ignition-key, so that the LED will turn on and flash red.

To correctly memorize the functions onto the keys of the steering-wheel commands, a programming-procedure needs to be effected, starting from function 1 (VOL-), all through the stated sequence indicated on the table.

Press steering-wheel command VOL- so that the LED will turn on and flash red, meaning that the memorization has taken place. This procedure is valid for all other functions: 2 (VOL+), 3 (SEEK-), 4 (SEEK+) etc.

ATTENTION:













The central-box is capable of executing 10 functions (12 functions for models from 2020).

ALL of these functions need to be either activated or deactivated.

Activation is made by pressing the keys on the steering-wheel.

Deactivation is made by pressing the PRG-key, located on the central-box.

Once the steering-wheel commands have been determined, the LED on the Interface will start flashing green.

Sequence for Function Memorization	FUNCTIONS PROGRAMMING TABLE							
	CAR-RADIO							
	Clarion	Kenwood	JVC	Pioneer	Sony	Alpine	Blaunpunkt	Phonocar
1	VOLUME -							
2	VOLUME +							
3	SEEK -							
4	SEEK +							
5	FUNC	SRC 	SOURCE	MODE	SOURCE	SOURCE	SOURCE	MODE
6	MUTE	MUTE	MUTE	MUTE	MUTE	MUTE	MUTE	MUTE
7	BAND	UP	UP	UP	UP		UP	PLAY/PAUSE
8	DISP	DOWN	DOWN	DOWN	DOWN		DOWN	BAND
9	TA	SPEECH				UP	OK	 *
10	AF					DOWN	NO	 *

*Only for VM057 (JACK3,5)

MEMORIZING THE CAR-RADIO PROFILE

Press SEEK+ to memorize the CLARION car-radios. To set other Makes, use the steering-wheel controls and press Vol+. To select the related Profile, check expected number of flashings with an intermediate pause. In case of errors, you can re-programme, by using Vol+ if flashings are less than indicated in the Table. Vol- if flashings are more than necessary. Press SEEK+ to confirm. LED will remain fix on Green colour.

Connect the Exit-cable of the steering-wheel commands to the back of the car-radio.

Check if the commands work correctly. In case of irregularities, RESET the central-unit and repeat the whole programming-procedure with great care.

CLARION	Do not press	Green led 1 flash	Press seek +
KENWOOD	Press once vol +	Green led 2 flash	Press seek +
JVC	Press 2 time vol +	Green led 3 flash	Press seek +
PIONEER	Press 3 time vol +	Green led 4 flash	Press seek +
PHONOCAR VM001, VM002, VM009 2017>, VM010, VM011D, VM012, VM030 2017>, VM051, VM057, VM066 2020>, VM067, VM069 SONY	Press 4 time vol +	Green led 5 flash	Press seek +
BLAUPUNKT ISO NORM	Press 4 time vol +	Green led 5 flash	Press seek +
ALPINE	Press 5 time vol +	Green led 6 flash	Press seek +
BLAUPUNKT	Press 9 time vol +	Red led 1 flash	Press seek +
PHONOCAR VM017, VM021, VM062, VM063	Press 11 time vol +	Red led 1 flash + 2 green	Press seek +
PHONOCAR VM044	Press 13 time vol +	Red led 1 flash + 3 green	Press seek +
BLAUPUNKT 2	Press 20 time vol +	Red led 2 flash + 1 green	Press seek +
BLAUPUNKT NEW YORK serie 800, SAN DIEGO serie 530	Press 23 time vol +	Red led 2 flash + 4 green	Press seek +
CLARION NX 501E	Press 26 time vol +	Red led 2 flash + 7 green	Press seek +
CLARION NX 502E	Press 32 time vol +	Red led 3 flash + 3 green	Press seek +
PHONOCAR VM025, VM026, VM028	Press 34 time vol +	Red led 3 flash + 5 green	Press seek +

GENERAL RESET

Unplug the connector from the central-unit. By keeping the PRG-key pressed, plug the connector again.

The LED of the central-unit will start flashing, first slowly then rapidly. Now lift the finger from the PRG-key. As soon as the RESET has been carried out successfully, the LED will turn RED and flash only once. If this does not happen, the Reset-operation needs to be repeated.

EXAMPLE Programming-procedure of a CLARION-car-radio, with 5KEYS available on the steering-wheel, to be used for : Vol-, Vol+, Seek-, Seek+, MUTE.

Sequence: press one time each Vol-, Vol+, Seek-, Seek+. Then press PRG on the central-unit, in order to deactivate the function (FUNC). Press MUTE-key and, finally, 4 times (6 times for models from 2020) the PRG-key to finish the programming-sequence.

When programming has successfully been carried out, the LED will continuously flash GREEN.

Now effect memorization of the car-radio.

MÉMORISATION TOUCHES

Après avoir effectué les branchements, sans insérer le jack commandes au volant dans le rétro de l'autoradio, tourner la clé d'allumage et le led s'illuminera avec un clignote de couleur rouge.













Pour mémoriser correctement les fonctions sur les touches des commandes au volant, faire la programmation en commençant de la fonction 1 (VOL -), en respectant la séquence présente sur le tableau.

Appuyer la commande au volant VOL - et le led s'illuminera avec un clignote de couleur rouge qui confirme la bonne mémorisation. Le même méthode devra être utilisé pour mémoriser les restantes fonctions 2 (VOL +), 3 (SEEK-), 4 (SEEK+) etc.

ATTENTION:

Le boîtier est prédisposé pour exécuter 10 fonctions (12 fonctions pour les modèles après 2020) qui devront être TOUTES Activées ou Désactivées. L'activation se vérifie en appuyant les touches présents sur le volant, au contraire la désactivation se vérifie en appuyant le touche PRG présent sur le boîtier.

Après avoir configuré les touches des commandes au volant le led de l'interface clignotera de couleur vert.

Séquence de mémorisation des fonctions	LISTE DE FONCTIONS A EFFECTUER POUR LA PROGRAMMATION							
	RADIO							
	Clarion	Kenwood	JVC	Pioneer	Sony	Alpine	Blaupunkt	Phonocar
1	VOLUME -							
2	VOLUME +							
3	SEEK -							
4	SEEK +							
5	FUNC	SRC 	SOURCE	MODE	SOURCE	SOURCE	SOURCE	MODE
6	MUTE	MUTE	MUTE	MUTE	MUTE	MUTE	MUTE	MUTE
7	BAND	UP	UP	UP	UP		UP	PLAY/PAUSE
8	DISP	DOWN	DOWN	DOWN	DOWN		DOWN	BAND
9	TA	SPEECH				UP	OK	 *
10	AF					DOWN	NO	 *

*Seulement par VM057 (JACK 3.5")

MÉMORISATION PROFIL AUTORADIO

Appuyer SEEK+ pour mémoriser les autoradios CLARION.

Pour effectuer la configuration d'autres marques, il faut agir sur les commandes au volant en appuyant la touche Vol+ et, pour sélectionner le profil, vérifier le numéro de clignotes corrects avec l'entracte d'une pause.

En cas d'erreur il est possible modifier la programmation à travers la touche Vol+, si le numéro de clignotes est inférieur à celui du tableau, et Vol-, s'il est supérieur.

Appuyer la touche SEEK+ pour confirmer. Le LED restera allumé avec la lumière verte fixe.

Brancher le câble sortie commandes au volant présente sur le rétro de l'autoradio.

Vérifier que les commandes fonctionnent correctement.

Si on a des anomalies, faire le reset du boîtier et répéter avec attention la procédure de programmation.

CLARION	Ne pas appuyer	Led vert 1 clignotement	Appuyer seek +
KENWOOD	Appuyer 1 fois vol+	Led vert 2 clignotement	Appuyer seek +
JVC	Appuyer 2 fois vol+	Led vert 3 clignotement	Appuyer seek +
PIONEER	Appuyer 3 fois vol+	Led vert 4 clignotement	Appuyer seek +
PHONOCAR VM001, VM002, VM009 2017>, VM010, VM011D, VM012, VM030 2017>, VM051, VM057, VM066 2020>, VM067, VM069 SONY	Appuyer 4 fois vol+	Led vert 5 clignotement	Appuyer seek +
BLAUPUNKT ISO NORM	Appuyer 4 fois vol+	Led vert 5 clignotement	Appuyer seek +
ALPINE	Appuyer 5 fois vol+	Led vert 6 clignotement	Appuyer seek +
BLAUPUNKT	Appuyer 9 fois vol+	Led vert 1 clignotement	Appuyer seek +
PHONOCAR VM017, VM021, VM062, VM063	Appuyer 11 fois vol+	Led rouge 1 clignotements + 2 vert	Appuyer seek +
PHONOCAR VM044	Appuyer 13 fois vol+	Led rouge 1 clignotements + 3 vert	Appuyer seek +
BLAUPUNKT 2	Appuyer 20 fois vol+	Led rouge 2 clignotements + 1 vert	Appuyer seek +
BLAUPUNKT NEW YORK SERIE 800, SAN DIEGO SERIE 530	Appuyer 23 fois vol+	Led rouge 2 clignotements + 4 vert	Appuyer seek +
CLARION NX 501E	Appuyer 26 fois vol+	Led rouge 2 clignotements + 7 vert	Appuyer seek +
CLARION NX 502E	Appuyer 32 fois vol+	Led rouge 3 clignotements + 3 vert	Appuyer seek +
PHONOCAR VM025, VM026, VM028	Appuyer 34 fois vol+	Led rouge 3 clignotements + 5 vert	Appuyer seek +

RESET GENERAL

Détacher le connecteur du boîtier et en tenant appuyer la touche PRG, réinsérer le connecteur.

Le LED du boîtier commencera à clignoter doucement et après plus rapidement; à ce point enlever la pression de la touche PRG. L'arrivé RESET sera confirmé avec un seul clignote de couleur rouge du LED. Si cela ne se vérifie pas, répéter l'opération.

EXEMPLE de procédure pour la programmation d'un autoradio Clarion avec disponibilité sur le volant de 5 touche en voulant obtenir les commandes de Vol-, Vol+, Seek-, Seek+, MUTE.

Séquence: appuyer une seule fois Vol-, Vol+, Seek-, Seek+, la touche PRG sur le boîtier pour désactiver la fonction (FUNC), la touche destiné au commande MUTE et à la fin appuyer 4 fois (12 fois pour les modèles après 2020) le touche PRG pour compléter la programmation. La bonne et correcte programmation sera confirmée par le clignote continu du LED de couleur vert.

Procéder pour la mémorisation de l'autoradio.

TASTEN-SPEICHERUNG

Verbindungen herstellen. Dann, ohne den Jack-Stecker der Lenkrad-Steuerungen hinten am Autoradio anzuschliessen, Zündschlüssel drehen. Das LED wird aufleuchten und Rot blinken.

Um die Funktionen korrekt auf den Lenkrad-Tasten einzuspeichern, die Programmierung in der angegebenen Reihenfolge vornehmen. Mit der Funktion 1 (VOL-) anfangen und lt. Tabelle fortfahren.

Lenkrad-Steuerung VOL- drücken, so dass das LED Rot aufblinkt und somit die Einspeicherung als erfolgt bestätigt.













Dieselbe Prozedur auch bei allen übrigen Funktionen vornehmen: 2 (VOL +), 3 (SEEK-), 4 (SEEK+) etc.

WICHTIG:

Die Zentraleinheit ist für 10 Funktionen ausgelegt (12 Funktionen für Modelle ab 2020), die ALLESAMT aktiviert oder deaktiviert werden müssen. Die Aktivierung erfolgt durch Druck auf die gegebenen Lenkrad-Tasten.

Die Deaktivierung erfolgt durch Druck auf die PRG-Taste der Zentraleinheit.

Nachdem alle Lenkrad-Tasten fertig programmiert sind, wird das LED der Interface Grün blinken.

Speichersequenz Funktionen	ANWEISUNGEN HINSICHTLICH DER PROGRAMMIERUNG							
	RADIO							
	Clarion	Kenwood	JVC	Pioneer	Sony	Alpine	Blaupunkt	Phonocar
1	VOLUME -							
2	VOLUME +							
3	SEEK -							
4	SEEK +							
5	FUNC	SRC 	SOURCE	MODE	SOURCE	SOURCE	SOURCE	MODE
6	MUTE	MUTE	MUTE	MUTE	MUTE	MUTE	MUTE	MUTE
7	BAND	UP	UP	UP	UP		UP	PLAY/ PAUSE
8	DISP	DOWN	DOWN	DOWN	DOWN		DOWN	BAND
9	TA	SPEECH				UP	OK	 *
10	AF					DOWN	NO	 *

*Nur für VM057 (JACK 3.5")

AUTORADIO-PROFIL-SPEICHERUNG

SEEK+ drücken, um CLARION-Autoradios einzuspeichern.

Um andere Marken einzustellen, Lenkrad-Steuerungen verwenden und dabei Vol+ drücken.

Sobald das zuständige Profil eingestellt ist, kontrollieren, ob das LED in der vorgesehenen Sequenz Blinken+Pause reagiert. Falls es nicht wie vorgesehen blinkt, kann man die Programmierung korrigieren: durch Vol+, falls das LED weniger als in der Tabelle angegeben blinkt. Durch Vol- falls es öfter als vorgesehen blinkt.

SEEK+ zur Bestätigung. LED bleibt fix auf Grün stehen.

Ausgangs-Kabel der Lenkrad-Steuerungen hinten am Autoradio anschließen.

Kontrollieren, ob alle Funktionen korrekt funktionieren.

Bei Betriebsstörungen, Zentraleinheit neu starten (Reset) und aufmerksam die gesamte Programmierungs-Prozedur neu vornehmen.

CLARION	Nicht drücken	Led grün 1 Aufblinken	SEEK + drücken
KENWOOD	1 Mal vol + drücken	Led grün 2 Aufblinken	SEEK + drücken
JVC	2 Mal vol + drücken	Led grün 3 Aufblinken	SEEK + drücken
PIONEER	3 Mal vol + drücken	Led grün 4 Aufblinken	SEEK + drücken
PHONOCAR VM001, VM002, VM009 2017>, VM010, VM011D, VM012, VM030 2017>, VM051, VM057, VM066 2020>, VM067, VM069 SONY	4 Mal vol + drücken	Led grün 5 Aufblinken	SEEK + drücken
BLAUPUNKT ISO NORM	4 Mal vol + drücken	Led grün 5 Aufblinken	SEEK + drücken
ALPINE	5 Mal vol + drücken	Led grün 6 Aufblinken	SEEK + drücken
BLAUPUNKT	9 Mal vol + drücken	Led rot 1 Aufblinken	SEEK + drücken
PHONOCAR VM017, VM021, VM062, VM063	11 Mal vol + drücken	Led rot blinkt 1 mal + 2 grün	SEEK + drücken
PHONOCAR VM044	13 Mal vol + drücken	Led rot blinkt 1 mal + 4 grün	SEEK + drücken
BLAUPUNKT 2	20 Mal vol + drücken	Led rot blinkt 2 mal + 1 grün	SEEK + drücken
BLAUPUNKT NEW YORK serie 800, SAN DIEGO serie 530	23 Mal vol + drücken	Led rot blinkt 2 mal + 4 grün	SEEK + drücken
CLARION NX 501E	26 Mal vol + drücken	Led rot blinkt 2 mal + 7 grün	SEEK + drücken
CLARION NX 502E	32 Mal vol + drücken	Led rot blinkt 3 mal + 3 grün	SEEK + drücken
PHONOCAR VM025, VM026, VM028	34 Mal vol + drücken	Led rot blinkt 3 mal + 5 grün	SEEK + drücken

GESAMT-RESET

Stecker aus der Zentraleinheit ziehen. Dann PRG-Taste gedrückt halten und Stecker wieder eingeben.

Das LED der Zentraleinheit wird zuerst langsam, dann schnell blinken. Jetzt Finger von der PRG-Taste nehmen. Das erfolgte RESET wird bestätigt durch das Einmalige rote Aufblinken des Leds. Falls dies nicht zutrifft, bitte Vorgang nochmals durchführen.

BEISPIEL einer Programmierungs-Prozedur mit CLARION-Autoradio und 5 belegbaren Lenkrad-Tasten für die Funktionen: Vol-, Vol+, Seek-, Seek+, MUTE.

Sequenz: Folgende Tasten jeweils nur 1 Mal drücken: Vol-, Vol+, Seek-, Seek+.

Dann Taste PRG auf der Zentraleinheit drücken, um die Funktion (FUNC) zu deaktivieren. Dann die Funktions-Taste drücken und letztendlich 4 Mal die PRG-Taste (12 Mal für Modelle ab 2020), um die Programmierung zu vervollständigen. Die korrekt abgeschlossene Programmierung wird bestätigt durch das beständige Blinken des grünen Leds. Nun kann die Autoradio-Einspeicherung vorgenommen werden.

MEMORIZACIÓN TECLAS

Después de haber efectuado las conexiones eléctricas, sin introducir el Jack de los mandos de volante en la parte trasera del autoradio girar la llave de contacto, el Led se iluminará con un destello de color rojo.













Para memorizar correctamente las funciones de las teclas presentes en el volante iniciar la programación desde la función 1 (VOL -), respetando la secuencia que se detalla en la tabla.

Presionar la tecla del volante que corresponde a VOL - a continuación el Led hará un destello de color rojo que confirma que ha sido memorizado. El mismo método tiene que ser aplicado al resto de las funciones presentes en el teclado del volante para que sean memorizadas por la centralita. A continuación se procederá a la siguiente memorización 2 (VOL +), 3 (SEEK-), 4 (SEEK+) etc.

ATENCIÓN:

La centralita puede memorizar hasta 10 funciones (12 funciones para modelos desde 2020) que deberán ser TODAS Activadas o Desactivadas obligatoriamente. La activación se produce cuando se memorizan las funciones de los mandos de volante en la centralita, mientras que la desactivación se produce presionando la tecla PRG presente en la centralita.

Después de haber configurado correctamente las teclas de los mandos de volante el Led de la centralita parpadeará de color verde.

Secuencia para memorizar las funciones	TABLA DE LAS FUNCIONES PARA EJECUTAR LA PROGRAMACION							
	RADIO							
	Clarion	Kenwood	JVC	Pioneer	Sony	Alpine	Blaunpunkt	Phonocar
1	VOLUME -							
2	VOLUME +							
3	SEEK -							
4	SEEK +							
5	FUNC	SRC 	SOURCE	MODE	SOURCE	SOURCE	SOURCE	MODE
6	MUTE	MUTE	MUTE	MUTE	MUTE	MUTE	MUTE	MUTE
7	BAND	UP	UP	UP	UP		UP	PLAY/PAUSE
8	DISP	DOWN	DOWN	DOWN	DOWN		DOWN	BAND
9	TA	SPEECH				UP	OK	 *
10	AF					DOWN	NO	 *

*Solo por VM057 (JACK 3.5")

MEMORIZACIÓN PERFIL AUTORADIO

Presionar SEEK+ para memorizar el perfil de las autoradios de la marca CLARION.

Para efectuar la configuración de las demás marcas, atenerse a la indicación presente en la tabla. Mediante la tecla Vol+ presente en los mandos del volante se procederá a configurar el perfil de la marca del autoradio. Según la marca de autoradio habrá que pulsar la tecla Vol + el número de veces que se indica (en la tabla) y a continuación hay que contar los destellos que el Led efectúa seguido de una pausa. Si los destellos del Led seguido de una pausa corresponden al perfil de la marca elegida presionar la tecla SEEK+ para confirmar.

En caso de error es posible modificar la programación mediante la tecla Vol+ si el número de destellos es inferior a lo que indica la tabla y Vol- si es superior. Después de presionar la tecla Seek + el LED quedará permanentemente encendido de color verde.

Conectar el cable (o el Jack) de los mandos de volante a la toma presente en la parte trasera del autoradio.

Verificar que los mandos del volante funcionen correctamente. En el caso de que no funcione correctamente, hacer un Reset a la centralita y repetir atentamente la programación.

CLARION	No Presionar	Led verde 1 parpadeo	Presionar seek+
KENWOOD	Presionar 1 Vece Vol +	Led verde 2 parpadeo	Presionar seek+
JVC	Presionar 2 Vece Vol +	Led verde 3 parpadeo	Presionar seek+
PIONEER	Presionar 3 Vece Vol +	Led verde 4 parpadeo	Presionar seek+
PHONOCAR VM001, VM002, VM009 2017>, VM010, VM011D, VM012, VM030 2017>, VM051, VM057, VM066 2020>, VM067, VM069 SONY	Presionar 4 Vece Vol +	Led verde 5 parpadeo	Presionar seek+
BLAUPUNKT ISO NORM	Presionar 4 Vece Vol +	Led verde 5 parpadeo	Presionar seek+
ALPINE	Presionar 5 Vece Vol +	Led verde 6 parpadeo	Presionar seek+
BLAUPUNKT	Presionar 9 Vece Vol +	Led verde 1 parpadeo	Presionar seek+
PHONOCAR VM017, VM021, VM062, VM063	Presionar 11 Vece Vol +	Led rojo 1 parpadeos + 2 verde	Presionar seek+
PHONOCAR VM044	Presionar 13 Vece Vol +	Led rojo 1 parpadeos + 4 verde	Presionar seek+
BLAUPUNKT 2	Presionar 20 Vece Vol +	Led rojo 2 parpadeos + 1 verde	Presionar seek+
BLAUPUNKT NEW YORK SERIE 800, SAN DIEGO SERIE 530	Presionar 23 Vece Vol +	Led rojo 2 parpadeos + 4 verde	Presionar seek+
CLARION NX 501E	Presionar 26 Vece Vol +	Led rojo 2 parpadeos + 7 verde	Presionar seek+
CLARION NX 502E	Presionar 32 Vece Vol +	Led rojo 3 parpadeos + 3 verde	Presionar seek+
PHONOCAR VM025, VM026, VM028	Presionar 34 Vece Vol +	Led rojo 3 parpadeos + 5 verde	Presionar seek+

RESET GENERAL

Quitar el conector de la centralita teniendo presionado la tecla PRG, volver a introducir en la centralita el conector.

A continuación el LED de la centralita iniciará a parpadear lentamente y después rápidamente en ese momento soltar la tecla PRG. Si La operación de Reset ha tenido éxito será confirmado mediante un solo destello de color rojo del Led. En el caso de que no se produjese ningún destello, repetir la operación.

EJEMPLO de programación para un autoradio de la marca Clarion en un coche con 5 funciones en los mandos de volante: Vol-, Vol+, Seek-, Seek+, MUTE. Secuencia: presionar una sola vez Vol-, Vol+, Seek-, Seek+, la tecla PRG en la centralita para desactivar la función (FUNC), después presionar en el volante la tecla MUTE y a continuación presionar 4 veces la tecla PRG (6 veces para modelos desde 2020) para completar la programación. La correcta programación, será confirmada por el continuo destello del LED de color verde. A continuación pasar a la siguiente fase, es decir a memorizar la marca del autoradio, tratándose de Clarion solo hay que presionar la tecla Seek + en el volante para confirmar. Para las demás marcas atenerse a las indicaciones del apartado MEMORIZACION PERFIL AUTORADIO

